



Compliance Testing

in accordance with the

40CFR60

Midland Cogeneration Venture

Midland, Michigan

Unit 13

August 2019

Prepared By:
Spectrum Systems, Inc.
3410 W. Nine Mile Rd.
Pensacola, Fl. 32526
(850)-944-3392

TABLE OF CONTENTS

- I. INTRODUCTION
- II. INSTALLATION DESCRIPTION
- III. SUMMARY OF RESULTS
- IV. STATEMENT OF AUTHENTICITY
- V. MATHEMATICAL EXPLANATION
- VI. REFERENCE METHODOLOGY

APPENDICES

- APPENDIX A Test Results Summary
- APPENDIX B Sampling System Bias Checks
- APPENDIX C Calculation of Emissions
- APPENDIX D Reference Method Raw Data Printouts
- APPENDIX E CEMS - Data Acquisition System
- APPENDIX F Analyzer Performance Results
- APPENDIX G RM Stratification Results
- APPENDIX H Gas Certificates
- APPENDIX I Fuel Analysis

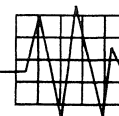

I. INTRODUCTION

Midland Cogeneration Venture (MCV) contracted Spectrum Systems, Inc., to perform Nitrogen Oxides and Carbon Monoxide compliance testing on Unit 13 located at 100 Progress Place in Midland, Michigan.

Testing was performed to satisfy the requirements contained in the Michigan Department of Environmental Quality (MDEQ) Renewable Operating Permit (ROP) No. MI-ROP- B6527-2014a. The tests were conducted according to the procedures outlined in the Code of Federal Regulations, Title 40, Part 60 (40CFR60) using sampling and calibration procedures specified in U.S. EPA Methods 3A, 7E, and 10.

The testing was conducted August 14th 2019 by James Garrett and Rick Artybridge of Spectrum Systems, Inc. (SSI). Ms. Barbara Vanderkelen of MCV coordinated the test events.

Contact Information

Affiliation	Address	Contact Info
Test Facility	Midland Cogeneration Venture 100 Progress Place Midland, Michigan 48640	Ms. Barb Vanderkelen 989-633-7937 bavanderkelen@midcogen.com
Test Company Rep.	Spectrum Systems, Inc. 3410 W. Nine Mile Rd. Pensacola, Florida 32526	Mr. James Garrett 850-944-3392 jgarrett@spectrumsystems.com
State Representative	MDEQ Department of Environmental Quality Air Quality Division Saginaw Bay District Headquarters 401 Ketchum St Suite B Bay City, MI 48708	Ben Witkopp

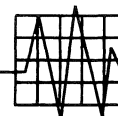

II. INSTALLATION DESCRIPTION

MCV produces steam and electricity from twelve combined-cycle natural gas-fired combustion turbines. Turbine Unit 3 through 14 are each rated with a maximum heat input of 984 million British thermal units (MMBtu) per hour and consist of a compressor, combustion turbine, and generator. Energy is generated at the combustion turbine by drawing in ambient air by means of burning fuel and expanding the hot combustion gases in a three-stage turbine.

Turbine Units 9 through 14 are also configured with supplemental natural gas-fired duct burners rated at 249mmBtu/hr maximum heat input. The duct burners utilize the hot exhaust gases from the combustion turbine to supplement the steam producing capabilities of the combined cycle turbine.

III. SUMMARY OF RESULTS

Results of the compliance testing are presented in Appendix A of this report. These results are based on test data obtained from the affected facility during two load conditions.

The testing was conducted according to the procedures in the Code of Federal Regulations, Title 40, Part 60 (40CFR60), Appendix A, Reference Methods 3A, 7E, and 10, for Oxygen (O₂), nitrogen oxide (NO_x), and carbon monoxide (CO), respectively. Emissions data analysis was performed according to 40 CFR 60 Appendix B.

The number of sampling points for each traverse of the stack was determined after a 12-point stratification test was performed. The probe was then connected to the Spectrum Systems, Inc.'s Transportable Continuous Emission Monitoring System (TCEMS). Sampling and analysis of the stack effluent stream was performed by the TCEMS Reference Method analyzer system. NO_x, CO and O₂ in-line analyzers measured NO_x, CO, and O₂ concentrations. Initial calibrations of the analyzers with EPA Protocol 1gases were conducted. Appropriate analyzer calibrations and analyzer bias and drift measurements were performed as required before, during, and after testing.

Three one-hour runs were performed at 55% and 100% load. Reference Method NO_x, CO and O₂ analyzer measurements were recorded on a one-minute continuous basis by the Reference Method TCEMS. An average of the NO_x, CO and O₂ concentrations is calculated for each run.

This report contains a summary of all the testing performed and the supporting data for all tests. Detailed test material is presented in the different appendices of this report. Refer to the header or footer information to pinpoint or sequence a group of data.

Appendix A of this report contains a summary of the final emissions results. Each summary page displays results for each run the page also displays the plant's gas flow, heat input, and megawatt

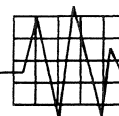

monitor readings. Average overall results are calculated by averaging the run averages of each parameter.

Appendix B of this report contains gas analyzer sampling system bias and drift results. These sheets contain the before and after calibration drift data obtained by introducing EPA Protocol 1 gases to the TCEMS analyzers between runs. This verifies that the TCEMS analyzers stay calibrated and operable during each run. This data is transferred to the Calculation of Average Emissions sheets and is used to correct the gas ppm concentrations.

Appendix C of this report contains Average Emissions Calculations results. There is a Calculation of Average Emissions sheet for each run. Each sheet contains the calibration and drift data and both the uncorrected and the corrected gas concentrations for the run.

Appendix D of this report contains Reference Method Raw DAHS data printouts. This includes raw gas calibration data and raw one-minute Reference Method TCEMS analyzer data readings with calculated gas run average concentrations.

Appendix E of this report contains Reference Method Quality Assurance Data. This includes the analyzer calibration error results, the gas interference tests, and the NOx converter efficiency test. Before any set of TCEMS analysis, the analyzers are calibrated with EPA Protocol 1 Gases and the Analyzer Calibration error is determined and verified to within specific limits. Interference tests and NOx converter efficiency tests are conducted on analyzers periodically.

Appendix F of this report contains plant process data during testing.

Appendix G of this report contains Stratification Data.

Appendix H of this report contains copies of the EPA Protocol Gas Certificates for the calibration gases used during calibration and calibration bias drift checks during testing.

Appendix I of this report contains the fuel analysis from the natural gas vendor.

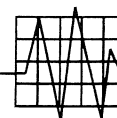

IV. STATEMENT OF AUTHENTICITY

The sampling and analysis for this report was carried out under my direction and supervision. I hereby certify that the details and results contained in this report are authentic and accurate to the best of my knowledge

Date: September 18, 2019

Signature: 

James Garrett
Testing QSTI

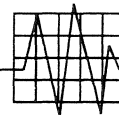

V. MATHEMATICAL EXPLANATION

Emission Calculations

Corrected Gas Pollutant Concentration in PPM

Calculate the correction for the gas analyzer measured gas concentrations in ppm, using sampling bias and drift measurements of EPA Protocol 1 zero and higher calibration gas concentrations.

When O₂ is used as the diluent gas during analysis, pollutant and O₂ ppm corrected readings are calculated using equation in 40 CFR 60 Appendix B Reference Method 7E Section 12 Equation 12.6. (Reference 40 CFR 60 Appendix B Reference Method 3A Section 9 for O₂ AND 40 CFR Appendix B Reference Method 7E Section 12 for NO_x BOTH reference procedure 40 CFR 60 Appendix B Reference Method 6C Section 8, Equation 12.6.)

$$C_{\text{gas}} = C_{\text{ma}} * (C_{\text{avg}} - C_{\text{o}}) / (C_{\text{m}} - C_{\text{o}})$$

Where:

- C gas = Corrected effluent gas concentration in ppm
- C_{ma} = Actual upscale calibration gas concentration in ppm
- C_{avg} = Gas analyzer reading in ppm
- C_o = Average of initial and final system calibration bias check response for the zero gas
- C_m = Average of initial and final system calibration bias check response for the upscale gas

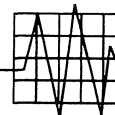

VI. REFERENCE METHODOLOGY

The sampling followed procedures as detailed in U.S. Environmental Protection Agency (EPA) Reference Methods as described in the Code of Federal Regulations 40CFR60, Appendix A. Discussions of these sampling, recovery, and analytical procedures are presented on the following pages.

Sampling point locations, or traverse points, were determined in accordance with 40CFR60, Appendix A 40CFR60, Appendix B, Performance Specification 2.

A general schematic of the Spectrum Systems, Inc. reference method testing transportable CEMS (TCEMS) appears below.

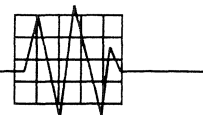
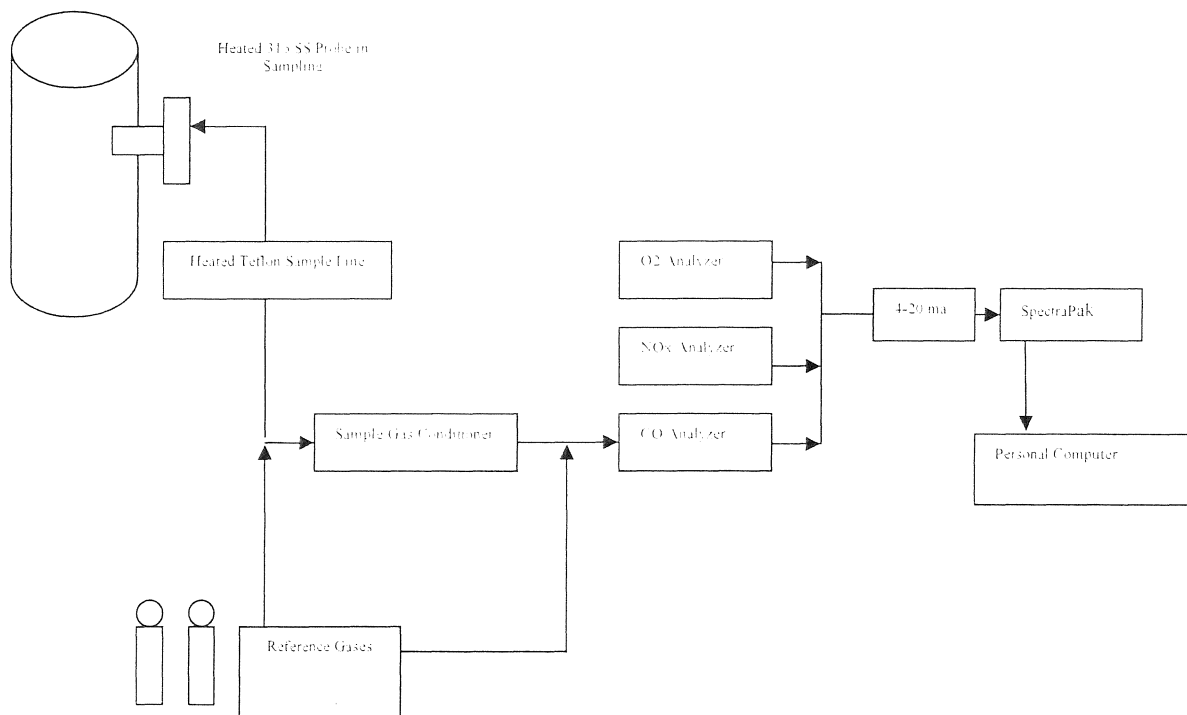

EPA Protocol One Standard Gas Concentrations

EPA Protocol One gas concentration levels are defined by 40CFR60, Method 7E Paragraph 3.3 A low-level concentration gas has a concentration less than 20.0 percent of the calibration span and may be a zero gas. A mid-level concentration gas has a concentration between 40.0 and 60.0 percent of the calibration span. A high-level concentration gas sets the calibration span and results in measurements being 20 to 100 percent of the calibration span. The Tester then chooses the reference gases that most closely approximate the plant effluent concentrations. Plant effluent concentrations change with different plant power levels.

TCEMS Quality Assurance Analyzer Performance Tests

TCEMS Analyzer Calibration Error Test

Prior to calibration of the TCEMS analyzers, an Analyzer Calibration Error test is performed on each analyzer. Each TCEMS analyzer is challenged with a zero-concentration reference gas and one or more known higher concentration reference gases in the ranges of the plant gas concentrations to be seen in testing. The analyzer's response for each gas used is recorded and a Calibration Error (CE) in percent is computed using the equation:

$$\text{Calibration Error (\%)} = ((\text{Monitor Response}) - (\text{Reference Gas})) / \text{Monitor Span} \times 100$$

Calibration Error values are used to adjust reference gas concentrations in the Sampling System's Bias and Drift test and in pollutant emission calculations from the reference method TCEMS analyzer system.

TCEMS Interference Checks

Each individual TCEMS analyzer is checked for chemical contaminants that may mask or alter the detection of the substance the monitor is measuring. The interference test is performed by periodically performing three runs on the TCEMS analyzers to verify the presence or absence of interferences. If the analyzer system is altered, interference tests are performed. If interferences are found to affect the readings of the analyzer, samples may need pretreatment processing to remove the interferences prior to analysis by the analyzer. Mechanisms for pretreatment may require use of impingers, absorbers, heating, filtration, chemical washing, etc. Treatment methods differ based on the chemicals involved. 40CFR60 Reference Methods discuss the specific sample pretreatment available. The results are retained and reported with each use of the analyzer.

TCEMS NO_x Converter Efficiency Test

Both nitrogen oxide (NO) and N=nitrogen dioxide (NO) gases can both be present in the effluent gases. The analyzers are designed to measure nitrogen oxide (NO) concentrations. To ensure measurement of

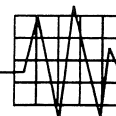

both types of gas, a NO₂ to NO converter is used, if needed, to convert all the nitrogen dioxide (NO₂) to nitrogen oxide (NO) for measurement. NO_x converter efficiencies are performed after each test and reported with TCEMS testing.

TCEMS Analyzer Calibration

Prior to plant sample analysis, the TCEMS analyzers are calibrated. EPA Protocol One reference gases are introduced into the TCEMS monitors. When stable, the analyzer responses are recorded and verified to be within the limits set forth in 40CFR60, Appendix A specific reference methods. Zero and higher EPA Protocol One reference gases are chosen for use based on the plant specific power levels and plant monitor full-scale spans. Refer to 40CFR60, Method 7E Paragraph 3.3 to choose the appropriate gas concentrations for use in testing.

TCEMS Sampling System Bias and Drift Check

Once TCEMS analyzer calibration error and analyzer calibrations are completed, the TCEMS is connected into the plant effluent sample traverse points. Effluent samples are obtained from a three-point traverse of the stack during sampling runs with durations of 20 minutes, per 40CFR60, Appendix B reference methods. The total run time of 60 minutes precludes, by at least twice, the Reference Method TCEMS response time.

Sampling bias and drift checks are conducted before and after each sampling run using the zero-reference gas and the appropriate higher reference gases. Each final zero and final higher reference gas calibration drift data values also serves as the initial zero and initial reference gas calibration drift data value for the following run.

The analyzer measurements are recorded on a continuous basis. Emission rates are computed for each parameter and diluent analyzer measurements after correction of pre-calibration and post-calibration drift data.

If something in the sampling or plant processes change, the system is recalibrated, sampling bias and drift is performed and the sampling test runs are restarted.

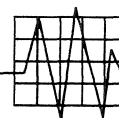

Plant Emission Sampling and Analysis

Plant Effluent Sampling (Traverse) Point Selection

Sampling point locations called traverse points, in the plant effluent stack for Continuous Emission Monitoring Systems are determined in accordance with 40CFR60, Appendix B, Performance Specification 2, Section 3. Each stack is built with a series of sample ports that allow a sample probe to be inserted. The TCEMS sampling probe is inserted into a sample port and moved into different positions called traverse points along the path across the stack. At each traverse position in the port, gas samples are collected and fed into the TCEMS analyzer train for analysis. The number of sample ports and traverse sample point locations in a port are chosen based on the size and shape of the effluent stack, flow rates, stack flow disturbances like elbows and bends, stack stratification, and, most importantly, representative stack emissions being released. The points were located at 16.7, 50.0, and 83.3 percent of the measurement line.

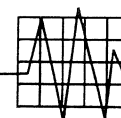
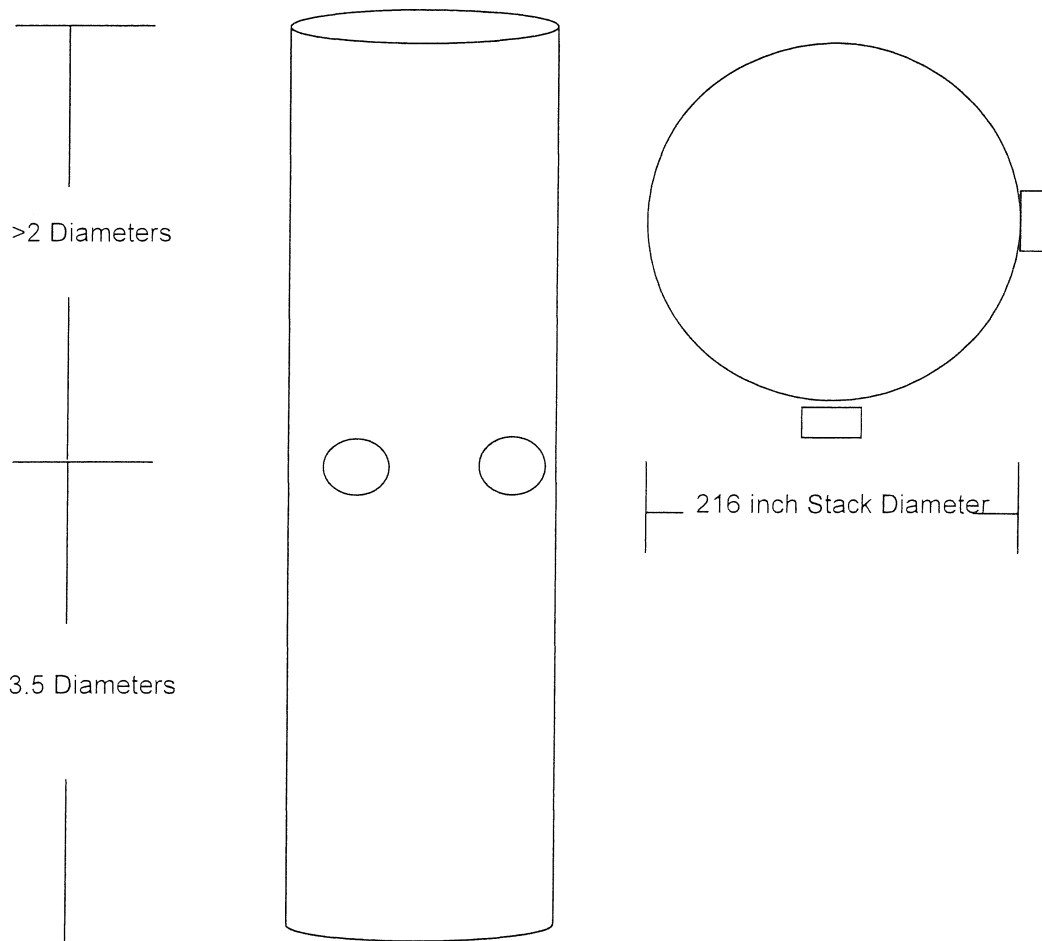

APPENDIX A
Test Results Summary

