

RECEIVED

NOV 10 2016

AIR QUALITY DIV.

EMISSIONS TEST REPORT

for

CARBON MONOXIDE (CO) EMISSIONS

ENGINES 1 & 2

**DTE-Gas Columbus Compressor Station
Columbus Township, Michigan**

September 20 & 28, 2016

Prepared By
Environmental Management & Resources
Environmental Field Services Group
DTE Corporate Services, LLC
7940 Livernois H-136
Detroit, MI 48210

DTE Energy®





CONTENTS

<u>Section</u>	<u>Page</u>
EXECUTIVE SUMMARY.....	IV
1.0 INTRODUCTION	1
2.0 SOURCE DESCRIPTION.....	1
3.0 SAMPLING AND ANALYTICAL PROCEDURES	2
3.1 OXYGEN AND CARBON MONOXIDE (USEPA METHODS 3A AND 10)	2
3.1.1 Sampling Method	2
3.1.2 O ₂ and CO Sampling Train	2
3.1.3 Sampling Duration & Frequency	3
3.1.4 Quality Control and Assurance (O ₂ and CO)	3
3.1.5 Data Reduction	3
4.0 OPERATING PARAMETERS	3
5.0 DISCUSSION OF RESULTS.....	3
6.0 CERTIFICATION STATEMENT	4

RESULTS TABLES

Table No. 1..... Engine 1 CO Emission Testing Results

Table No. 2..... Engine 2 CO Emission Testing Results



FIGURES

- 1 Engines 1 & 2 Stack Drawing & Exhaust Sampling Point Location
- 2 USEPA Method 3A and 10 Sampling Train

APPENDICES

- A MDEQ Test Plan and Approval Letter
- B Raw Analyzer Data
- C Equipment and Analyzer Calibration Data
- D Operational Data
- E Example Calculations

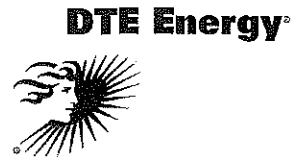

EXECUTIVE SUMMARY

DTE Energy’s Environmental Management and Resources (EM&R), Field Services Group, performed emissions testing at the DTE-Gas Columbus Compressor Station, located in Columbus, Michigan. The fieldwork, performed on September 20 & 28, 2016, was conducted to satisfy requirements of the Michigan Air Renewable Operating Permit No. B6480-2012d and 40 CFR Part 63 NESHAP Subpart ZZZZ. Emission testing was performed on Engines 1 & 2 at the inlet and outlet of each engine’s catalyst.

The results of the emissions testing are highlighted below:

**Emissions Testing Summary
Columbus Compressor Station
Engines 1 & 2
September 20 & 28, 2016**

Parameter	Engine 1 (9/28)	Engine 2 (9/20)
Average Inlet Carbon Monoxide Emissions (gram/BHP-Hr, dry)	0.55	0.98
Average Outlet Carbon Monoxide Emissions (gram/BHP-Hr, dry)	0.003	0.001
Average Carbon Monoxide Reduction Efficiency (93%) ⁽¹⁾	99.4	99.9

⁽¹⁾ (Permit Limit)



RECEIVED

NOV 10 2016

AIR QUALITY DIV.

1.0 INTRODUCTION

DTE Energy's Environmental Management and Resources (EM&R), Field Services Group, performed emissions testing at the DTE-Gas Columbus Compressor Station, located in Columbus, Michigan. The fieldwork, performed on September 20 & 28, 2016, was conducted to satisfy requirements of the Michigan Air Renewable Operating Permit No. B6480-2012d and 40 CFR Part 63 NESHAP Subpart ZZZZ. Emission testing was performed on Engines 1 & 2 at the inlet and outlet of each engine's catalyst.

Testing was performed pursuant to Title 40, *Code of Federal Regulations*, Part 60, Appendix A (40 CFR §60 App. A), Methods 3A and 10.

The fieldwork was performed in accordance with EPA Reference Methods and DTE's Intent to Test¹, Test Plan Submittal. The following DTE personnel participated in the testing program: Mark Grigereit, Principal Engineer and Mr. Fred Meinecke, Senior Environmental Technician. Mr. Grigereit was the project leader. Mr. Reza Bagherian, USEPA, Region V was notified of the emissions testing. Mr. Robert Elmouchi with the Michigan Department of Environmental Quality observed the emissions testing.

2.0 SOURCE DESCRIPTION

The Columbus Compressor Station located at 1647 Caughill Road, Columbus, Michigan, employs the use of two (2) DeLaval, 4-cycle, lean burn, natural gas-fired 2,000 Horse Power reciprocating engines. The engines generate line pressure assisting in the transmission of natural gas throughout the pipeline transmission system in SE Michigan.

The emissions from Engines 1 & 2 are exhausted through a catalyst bed and to the atmosphere through individual exhaust stacks. The composition of the emissions from the engines depend both upon the speed of the engine and the torque delivered to the compressor. Ambient atmospheric conditions, as it affects the density of air, may limit the speed and torque at which the engines can effectively operate on a daily basis.

Schematic representations of each engine's exhaust and sampling locations are presented in Figure 1.

¹ MDEQ, Test Plan, Submitted August 30, 2016. (Attached-Appendix A)

3.0 SAMPLING AND ANALYTICAL PROCEDURES

DTE Energy obtained emissions measurements in accordance with procedures specified in the USEPA *Standards of Performance for New Stationary Sources*. The sampling and analytical methods used in the testing program are indicated in the table below

Sampling Method	Parameter	Analysis
USEPA Method 3A	Oxygen	Instrumental Analyzer Method
USEPA Method 10	Carbon Monoxide	NDIR

3.1 OXYGEN AND CARBON MONOXIDE (USEPA METHODS 3A AND 10)

3.1.1 Sampling Method

Oxygen (O₂) emissions were evaluated using USEPA Method 3A, “Gas Analysis for Carbon Dioxide, Oxygen, Excess Air, and Dry Molecular Weight (Instrumental Analyzer Method)”. The O₂ analyzer utilizes a paramagnetic sensor.

Carbon monoxide (CO) emissions were evaluated using USEPA Method 10, “Determination of Carbon Monoxide Emissions from Stationary Sources”. The CO analyzer utilizes a NDIR detector.

3.1.2 O₂ and CO Sampling Train

The EPA Methods 3A and 10 sampling system (Figure 2) consisted of the following components:

- (1) Stainless steel sampling probe.
- (2) Heated PTFE sampling line.
- (3) Sampling gas conditioner with particulate filter.
- (4) Flexible unheated PTFE sampling line.
- (5) Servomax 1400 O₂/CO₂ gas analyzer and TECO 48i NDIR CO gas analyzer.
- (6) USEPA Protocol 1 calibration gases.
- (7) Data Acquisition System.



3.1.3 Sampling Duration & Frequency

The emissions testing of the engine consisted of triplicate 15-minute samples at the inlet and exhaust of each catalyst. Sampling was conducted in a centroid position at each sampling location and was performed simultaneously for O₂ and CO. Data was recorded at 10-second intervals.

3.1.4 Quality Control and Assurance (O₂ and CO)

All sampling and analytical equipment was calibrated according to the guidelines referenced in Methods 3A and 7E. Calibration gases were EPA Protocol 1 gases and the concentrations were within the acceptable ranges (40-60% mid range and span) specified in Method 7E.

Calibration gas certification sheets are located in Appendix C.

3.1.5 Data Reduction

Data collected during the emissions testing was recorded at 10-second intervals and averaged in 1-minute increments. The CO emissions were recorded in parts per million (ppm). The 1-minute readings collected can be found in Appendix B.

Emissions calculations are based on calculations located in USEPA Methods 7E, 10, and 19 and can be found in Appendix E. The CO emissions data collected during the testing was calculated as grams per brake horsepower-hour (g/BHp-Hr).

4.0 OPERATING PARAMETERS

The test program included the collection of engine torque (%), engine speed (RPM), Horsepower (BHp), inlet and exhaust manifold air temperature (°F) suction and discharge pressure (psig), fuel upper heating value (BTU), and fuel flow (SCFH). Operational data is located in Appendix D.

5.0 DISCUSSION OF RESULTS

The results of the CO emission testing on Engines 1 & 2 are presented in Tables No. 1 and No. 2. The CO emissions are presented in grams per brake horsepower hour (g/Bhp-Hr), prior to and after the catalyst, and the Destruction Efficiency in percent (%). Process data presented includes the Unit load in percent (%), Engine Speed in revolutions per minute (RPM), Engine Torque in brake horsepower (Brake-hp), and Heat Input in million British Thermal Unit per hour (MMBtu/hr) for each test. The results of the testing indicate that Engines 1 & 2 are in compliance with permit requirements for CO of 93% Destruction Efficiency.

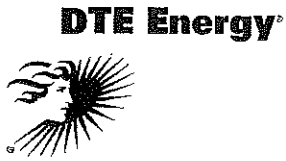

6.0 CERTIFICATION STATEMENT

"I certify that I believe the information provided in this document is true, accurate, and complete. Results of testing are based on the good faith application of sound professional judgment, using techniques, factors, or standards approved by the Local, State, or Federal Governing body, or generally accepted in the trade."

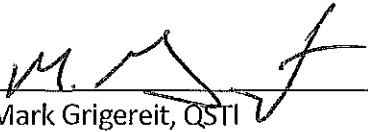

Mark Grigereit, QSTI

This report prepared by:



Mr. Mark Grigereit, QSTI
Principal Engineer, Field Services Group
Environmental Management and Resources
DTE Energy Corporate Services, LLC

This report reviewed by:



Mr. Thom Snyder, QSTI
Environmental Specialist, Field Services Group
Environmental Management and Resources
DTE Energy Corporate Services, LLC

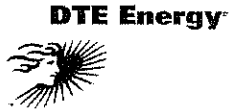

TABLE NO. 1
CARBON MONOXIDE (CO) EMISSION TESTING RESULTS
 Engine 1 - Columbus Compressor Station
 September 28, 2016

Test	Time	Load (%)	Speed (RPM)	Brake-HP	Heat Input (MMBtu/Hr)	Oxygen ⁽¹⁾		CO Emissions ⁽¹⁾			Destruction Efficiency (%)
						Inlet (%)	Outlet (%)	Outlet (ppm @ 15% O ₂)	Inlet (g/BHp-Hr)	Outlet (g/BHp-Hr)	
Run - 1	9:45-10:00	95.0	468.0	1,487	10.87	10.2	10.2	0.3	0.57	0.002	99.6
Run - 2	10:07-10:22	95.0	471.5	1,503	10.97	10.0	10.0	0.7	0.54	0.005	99.1
Run - 3	10:35-10:50	<u>97.0</u>	<u>464.0</u>	<u>1,504</u>	<u>10.94</u>	<u>9.9</u>	<u>9.9</u>	<u>0.3</u>	<u>0.54</u>	<u>0.002</u>	<u>99.6</u>
	<i>Avg:</i>	95.7	467.8	1,498	10.93	10.0	10.0	0.5	0.55	0.003	99.4

(1) Corrected for analyzer drift per USEPA method 7E

CO Permit Limits:

93% DE or 47 ppm @ 15% O₂

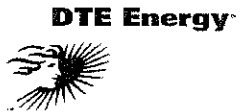

TABLE NO. 2
CARBON MONOXIDE (CO) EMISSION TESTING RESULTS
 Engine 2 - Columbus Compressor Station
 September 20, 2016

Test	Time	Load (%)	Speed (RPM)	Brake-HP	Heat Input (MMBtu/Hr)	Oxygen ⁽¹⁾		CO Emissions ⁽¹⁾			Destruction Efficiency (%)
						Inlet (%)	Outlet (%)	Outlet (ppm @ 15% O ₂)	Inlet (g/BHp-Hr)	Outlet (g/BHp-Hr)	
Run - 1	11:45-12:00	77.5	451.5	1,166	9.47	12.2	12.3	0.1	0.98	0.001	99.9
Run - 2	12:08-12:23	76.5	452.5	1,154	9.45	12.2	12.3	0.1	0.98	0.001	99.9
Run - 3	12:32-12:47	<u>74.5</u>	<u>450.5</u>	<u>1,119</u>	<u>9.37</u>	<u>12.2</u>	<u>12.3</u>	<u>0.2</u>	<u>0.99</u>	<u>0.002</u>	<u>99.8</u>
	<i>Avg:</i>	<i>76.2</i>	<i>451.5</i>	<i>1,146</i>	<i>9.43</i>	<i>12.2</i>	<i>12.3</i>	<i>0.1</i>	<i>0.98</i>	<i>0.001</i>	<i>99.9</i>

(1) Corrected for analyzer drift per USEPA method 7E

CO Permit Limits:

93% DE or 47 ppm @ 15% O₂

DTE Energy



FIGURES



Figure 1 – Sampling Location
Columbus Compressor Station - Engines 1 & 2
September 20 & 28, 2016

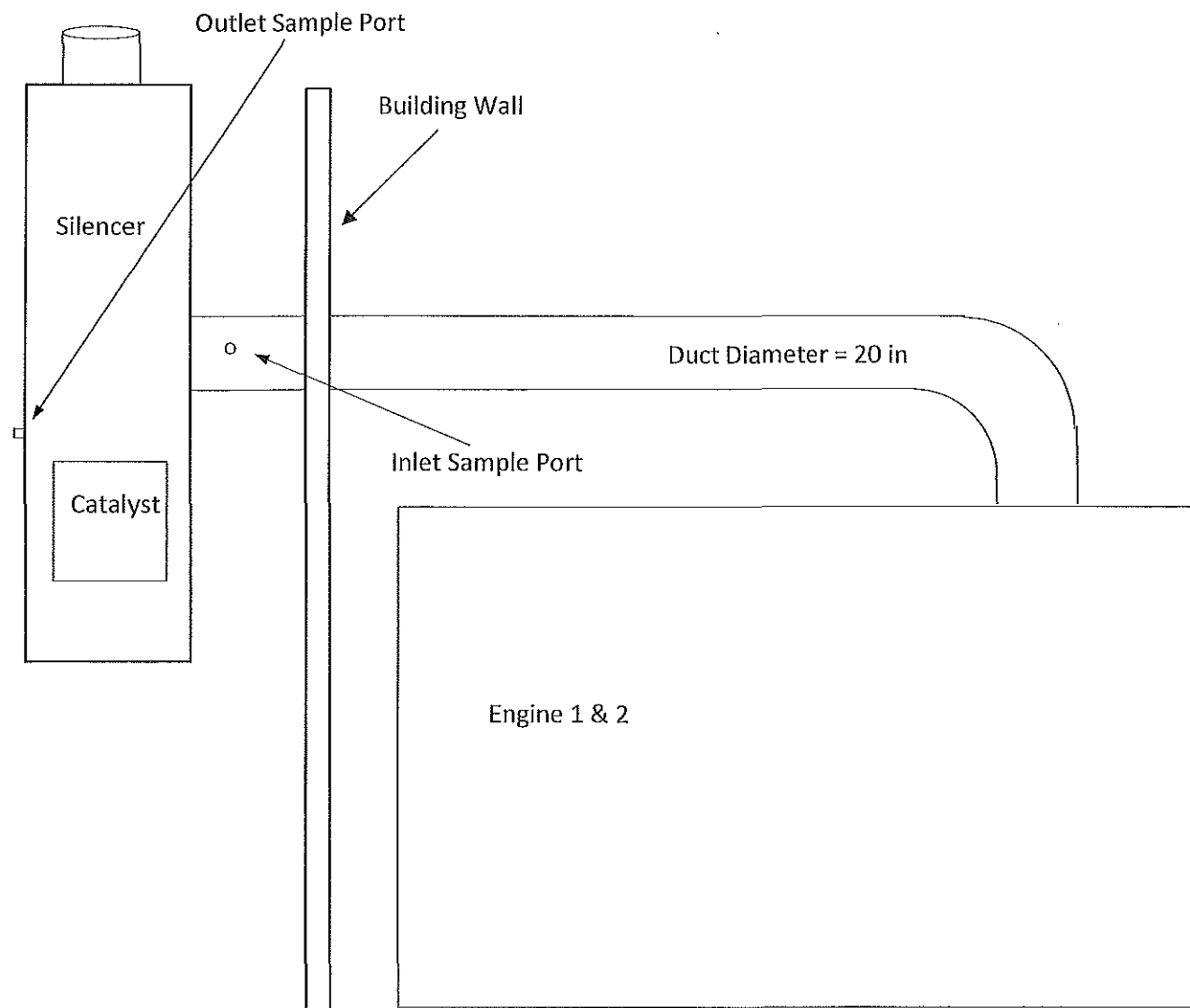
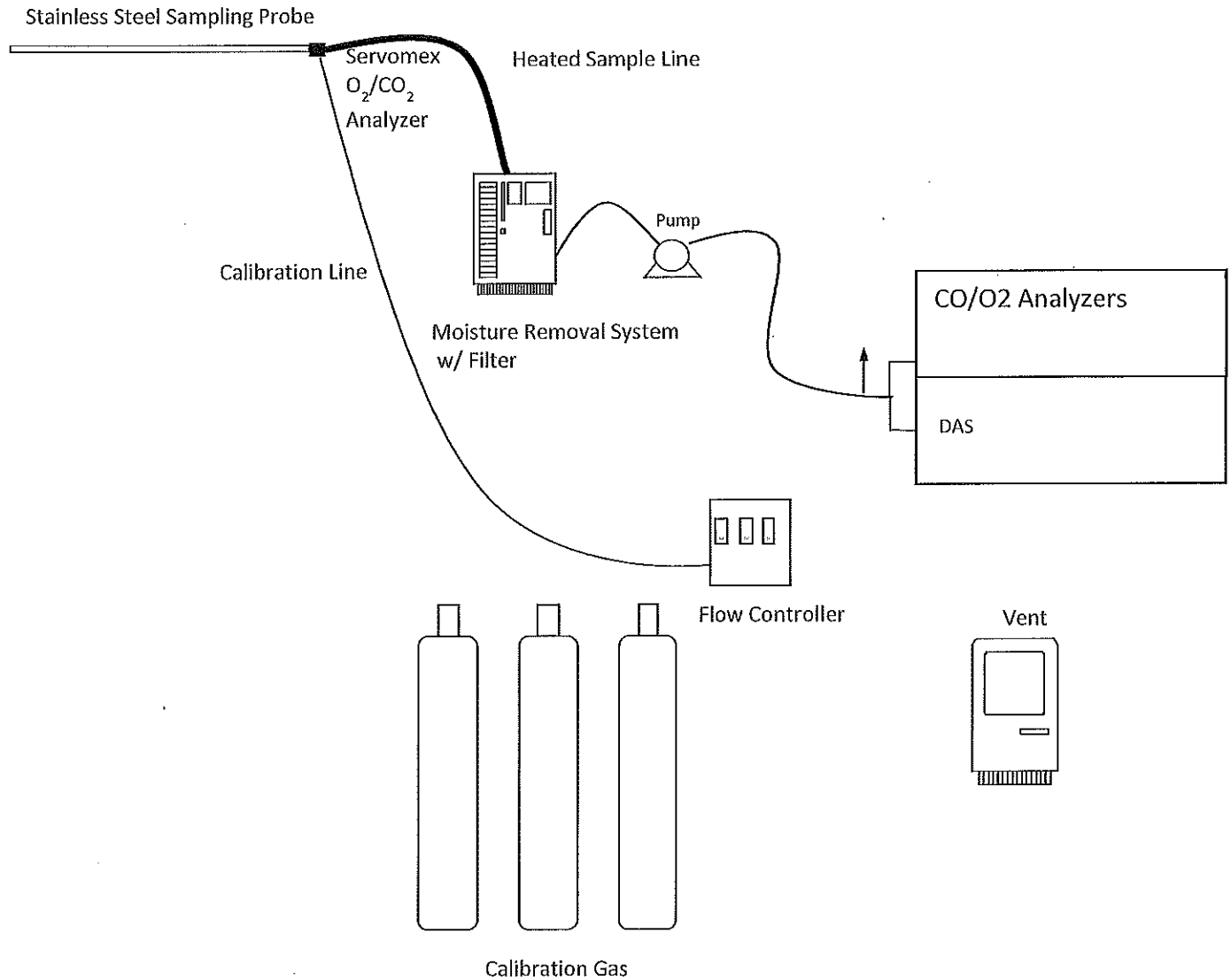



Figure 2 – EPA Methods 3A/10
Columbus Compressor Station
September 20 & 28, 2016



DTE Energy



APPENDIX A

MDEQ TEST PLAN